

ESD7004

Transient Voltage Suppressors

Low Capacitance ESD Protection Diode for High Speed Data Line

The ESD7004 transient voltage suppressor is designed to protect high speed data lines from ESD. Ultra-low capacitance and low ESD clamping voltage make this device an ideal solution for protecting voltage sensitive high speed data lines. The flow-through style package allows for easy PCB layout and matched trace lengths necessary to maintain consistent impedance between high speed differential lines such as USB 3.0 and HDMI.

Features

- Low Capacitance (0.4 pF Typical, I/O to GND)
- Protection for the Following IEC Standards:
IEC 61000-4-2 (Level 4)
- Low ESD Clamping Voltage
- This is a Pb-Free Device

Typical Applications

- USB 3.0
- HDMI
- Display Port
- eSATA

MAXIMUM RATINGS (T_J = 25°C unless otherwise noted)

Rating	Symbol	Value	Unit
Operating Junction Temperature Range	T _J	-55 to +125	°C
Storage Temperature Range	T _{stg}	-55 to +150	°C
Lead Solder Temperature – Maximum (10 Seconds)	T _L	260	°C
IEC 61000-4-2 Contact (ESD)	ESD	±15	kV
IEC 61000-4-2 Air (ESD)	ESD	±15	kV

Stresses exceeding Maximum Ratings may damage the device. Maximum Ratings are stress ratings only. Functional operation above the Recommended Operating Conditions is not implied. Extended exposure to stresses above the Recommended Operating Conditions may affect device reliability.

See Application Note AND8308/D for further description of survivability specs.



ON Semiconductor®

<http://onsemi.com>

MARKING DIAGRAM



UDFN10
CASE 517BB

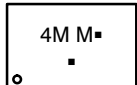

4M = Specific Device Code (tbd)
M = Date Code
▪ = Pb-Free Package
(*Note: Microdot may be in either location)

PIN CONFIGURATION AND SCHEMATIC

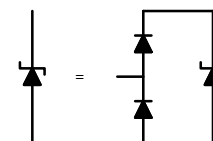
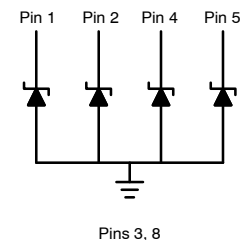
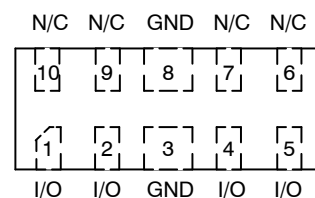

ORDERING INFORMATION

Device	Package	Shipping
ESD7004MUTAG	UDFN10 (Pb-Free)	3000 / Tape & Reel

†For information on tape and reel specifications, including part orientation and tape sizes, please refer to our Tape and Reel Packaging Specification Brochure, BRD8011/D.

ESD7004

ELECTRICAL CHARACTERISTICS ($T_A = 25^\circ\text{C}$ unless otherwise specified)

Parameter	Symbol	Conditions	Min	Typ	Max	Unit
Reverse Working Voltage	V_{RWM}	I/O Pin to GND			5.0	V
Breakdown Voltage	V_{BR}	$I_T = 1\text{ mA}$, I/O Pin to GND	5.5			V
Reverse Leakage Current	I_R	$V_{RWM} = 5\text{ V}$, I/O Pin to GND			1.0	μA
Clamping Voltage (Note 1)	V_C	$I_{PP} = 1\text{ A}$, I/O Pin to GND (8 x 20 μs pulse)			10	V
Clamping Voltage (Note 2)	V_C	IEC61000-4-2, $\pm 8\text{ KV}$ Contact	See Figures 1 and 2			V
Clamping Voltage TLP (Note 3) See Figures 6 through 9	V_C	$I_{PP} = 8\text{ A}$ $I_{PP} = 16\text{ A}$ $I_{PP} = -8\text{ A}$ $I_{PP} = -16\text{ A}$		11.4 15.6 -4.5 -8.1		
Junction Capacitance	C_J	$V_R = 0\text{ V}$, $f = 1\text{ MHz}$ between I/O Pins		0.2	0.3	pF
Junction Capacitance	C_J	$V_R = 0\text{ V}$, $f = 1\text{ MHz}$ between I/O Pins and GND		0.4	0.5	pF

- Surge current waveform per Figure 5.
- For test procedure see Figures 3 and 4 and application note AND8307/D.
- ANSI/ESD STM5.5.1 – Electrostatic Discharge Sensitivity Testing using Transmission Line Pulse (TLP) Model.
TLP conditions: $Z_0 = 50\ \Omega$, $t_p = 100\text{ ns}$, $t_r = 4\text{ ns}$, averaging window; $t_1 = 30\text{ ns}$ to $t_2 = 60\text{ ns}$.

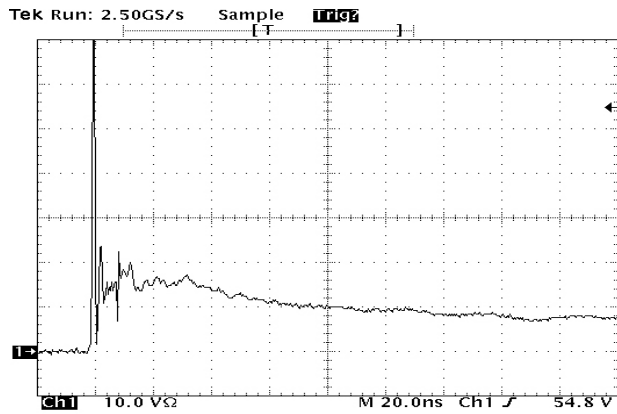

Figure 1. IEC61000-4-2 +8 KV Contact ESD Clamping Voltage

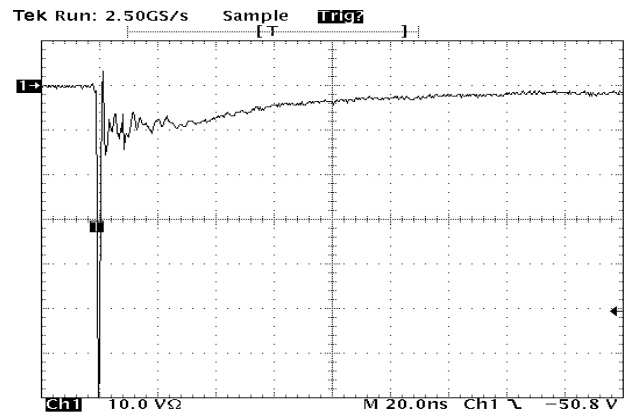

Figure 2. IEC61000-4-2 -8 KV Contact ESD Clamping Voltage

ESD7004

IEC 61000-4-2 Spec.

Level	Test Voltage (kV)	First Peak Current (A)	Current at 30 ns (A)	Current at 60 ns (A)
1	2	7.5	4	2
2	4	15	8	4
3	6	22.5	12	6
4	8	30	16	8

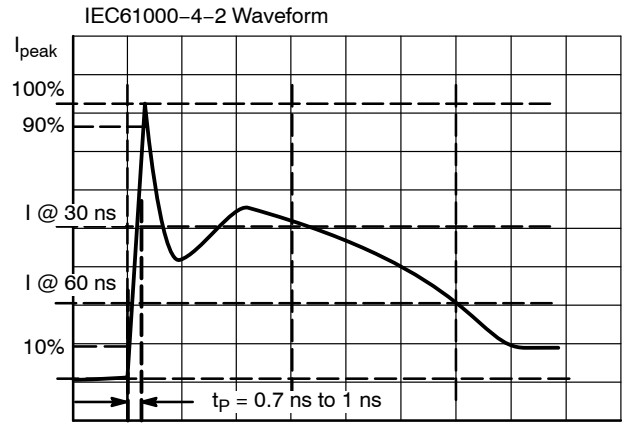

Figure 3. IEC61000-4-2 Spec

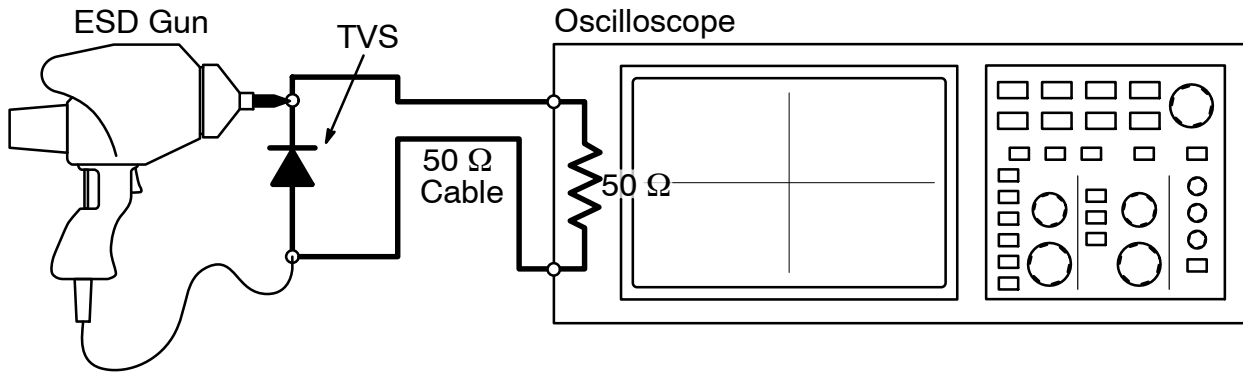

Figure 4. Diagram of ESD Clamping Voltage Test Setup

The following is taken from Application Note AND8308/D – Interpretation of Datasheet Parameters for ESD Devices.

ESD Voltage Clamping

For sensitive circuit elements it is important to limit the voltage that an IC will be exposed to during an ESD event to as low a voltage as possible. The ESD clamping voltage is the voltage drop across the ESD protection diode during an ESD event per the IEC61000-4-2 waveform. Since the IEC61000-4-2 was written as a pass/fail spec for larger

systems such as cell phones or laptop computers it is not clearly defined in the spec how to specify a clamping voltage at the device level. ON Semiconductor has developed a way to examine the entire voltage waveform across the ESD protection diode over the time domain of an ESD pulse in the form of an oscilloscope screenshot, which can be found on the datasheets for all ESD protection diodes. For more information on how ON Semiconductor creates these screenshots and how to interpret them please refer to AND8307/D.

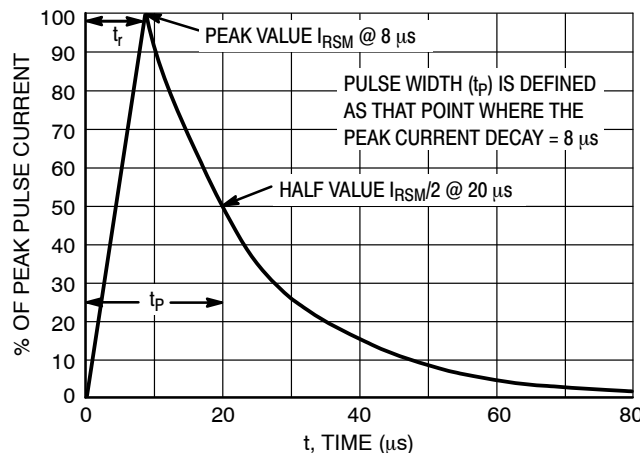

Figure 5. 8 X 20 μs Pulse Waveform

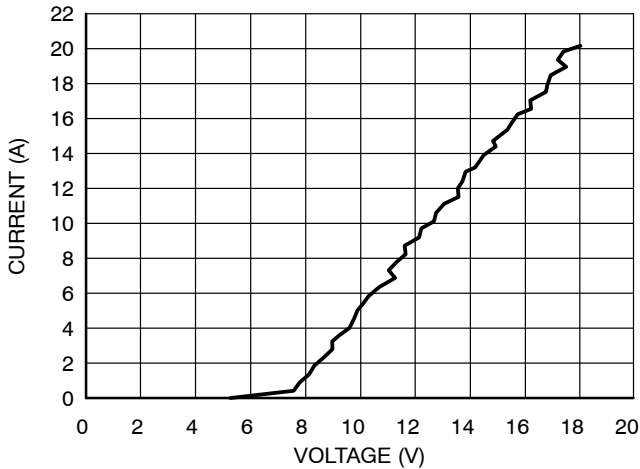

Figure 6. Positive TLP I-V Curve

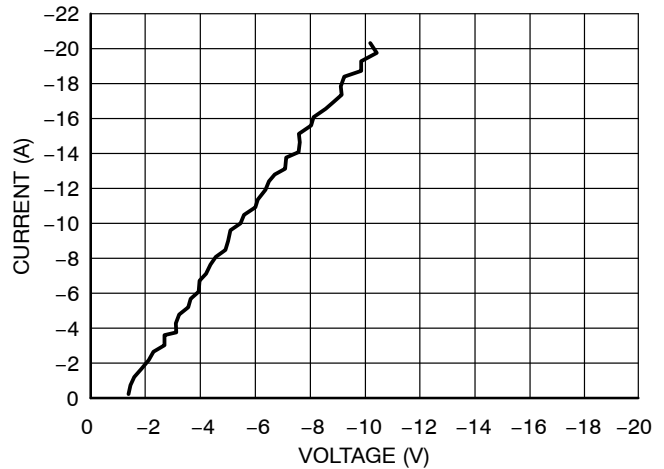

Figure 7. Negative TLP I-V Curve

Transmission Line Pulse (TLP) Measurement

Transmission Line Pulse (TLP) provides current versus voltage (I-V) curves in which each data point is obtained from a 100 ns long rectangular pulse from a charged transmission line. A simplified schematic of a typical TLP system is shown in Figure 8. TLP I-V curves of ESD protection devices accurately demonstrate the product’s ESD capability because the 10s of amps current levels and under 100 ns time scale match those of an ESD event. This is illustrated in Figure 9 where an 8 kV IEC 61000-4-2 current waveform is compared with TLP current pulses at 8 A and 16 A. A TLP I-V curve shows the voltage at which the device turns on as well as how well the device clamps voltage over a range of current levels. A typical TLP I-V curve for the ESD7004 is shown in Figures 6 and 7.

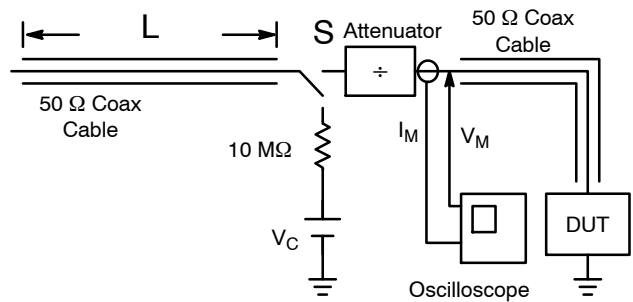

Figure 8. Simplified Schematic of a Typical TLP System

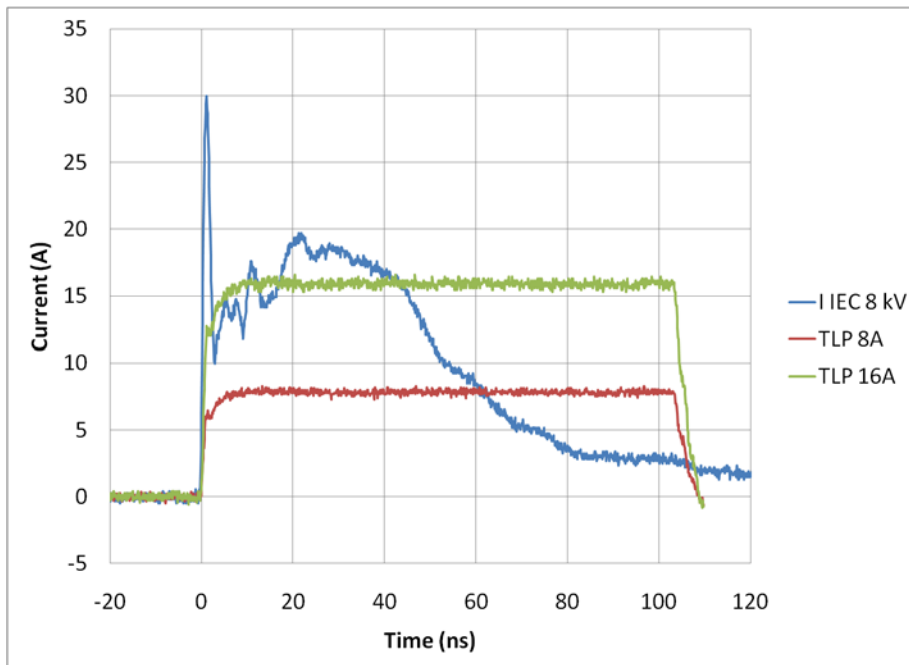
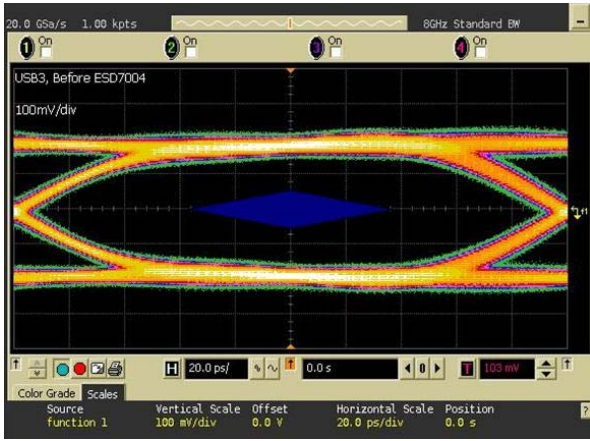
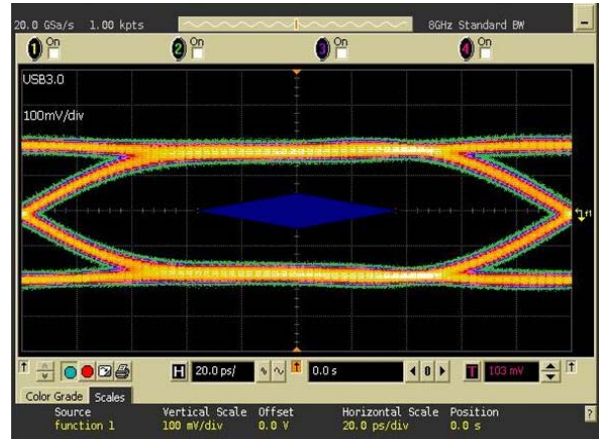

Figure 9. Comparison Between 8 kV IEC 61000-4-2 and 8 A and 16 A TLP Waveforms

ESD7004



Without ESD



With ESD7004

Figure 10. USB3.0 Eye Diagram with and without ESD7004. 5.0 Gb/s, 400 mV_{pp}

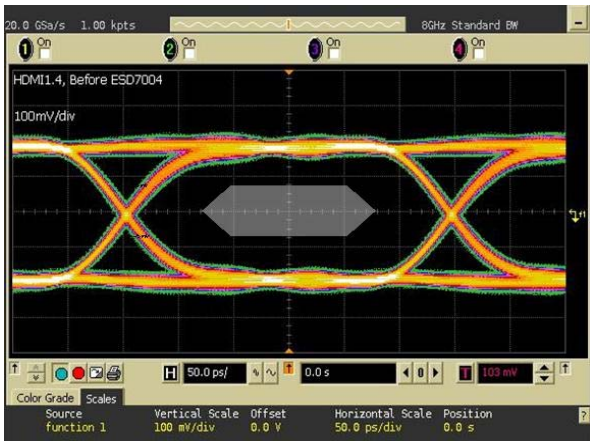

Without ESD

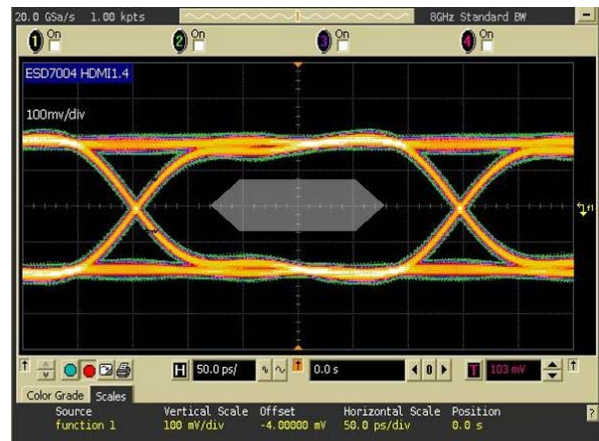

With ESD7004

Figure 11. HDMI1.4 Eye Diagram with and without ESD7004. 3.4 Gb/s, 400 mV_{pp}

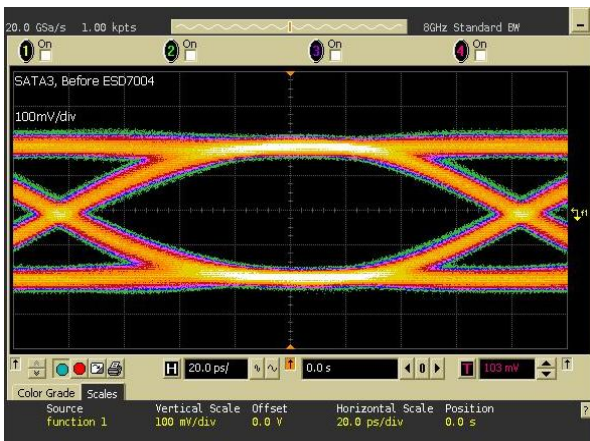

Without ESD

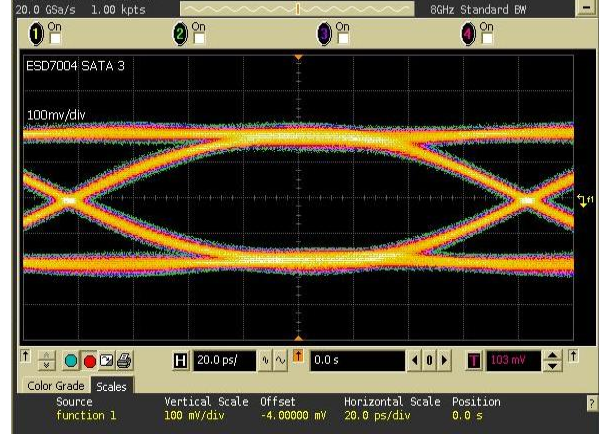

With ESD7004

Figure 12. ESATA3.0 Eye Diagram with and without ESD7004. 6 Gb/s, 400 mV_{pp}

ESD7004

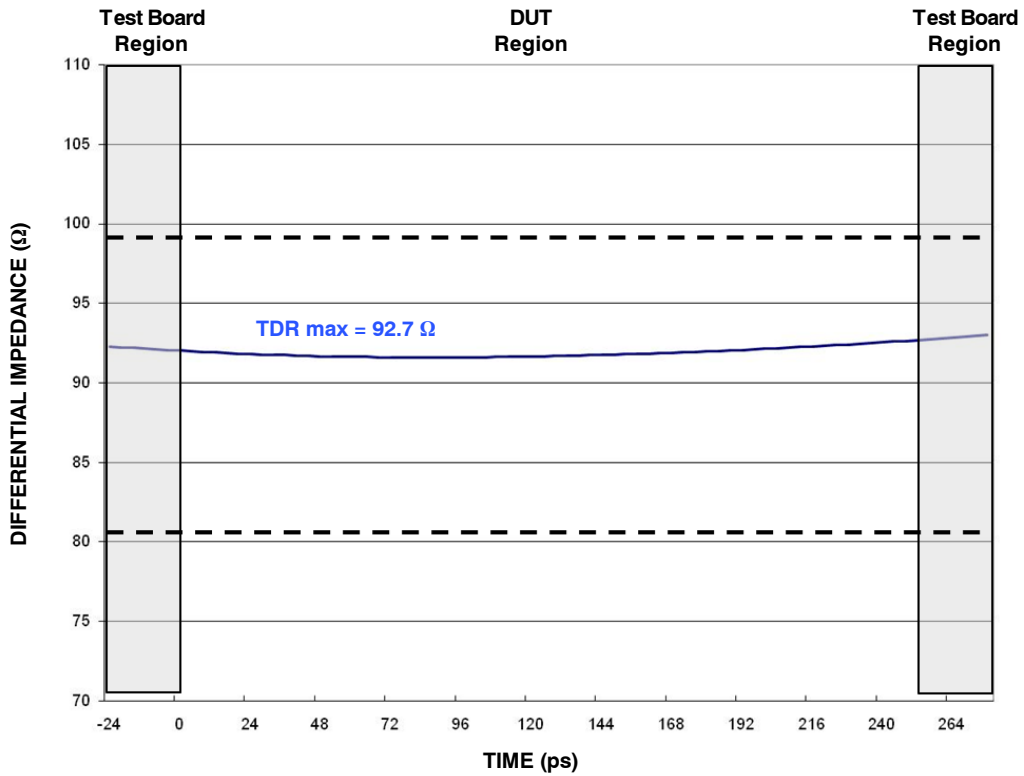

** USB spec requirement is $90 \Omega \pm 10\%$ — — — — —

Figure 13. USB TDR Measurement. 90Ω Differential Impedance Target, 200 ps Rise Time

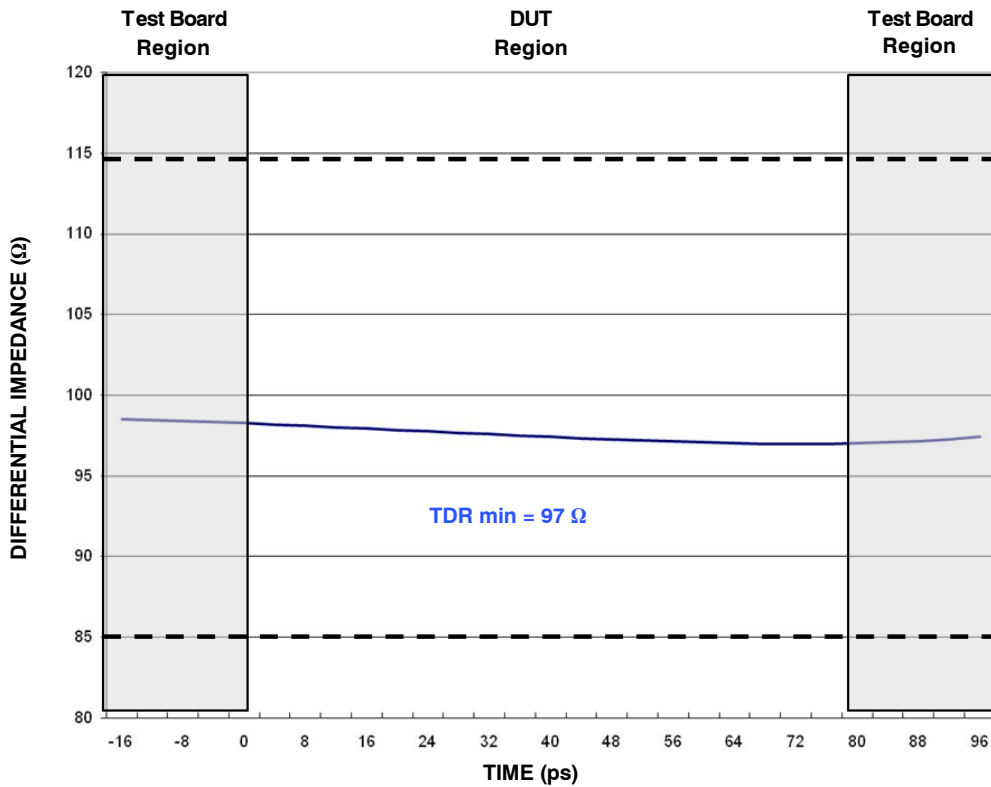

** HDMI spec requirement is $100 \Omega \pm 15\%$ — — — — —

Figure 14. HDMI TDR Measurement. 100Ω Differential Impedance Target, 200 ps Rise Time

ESD7004

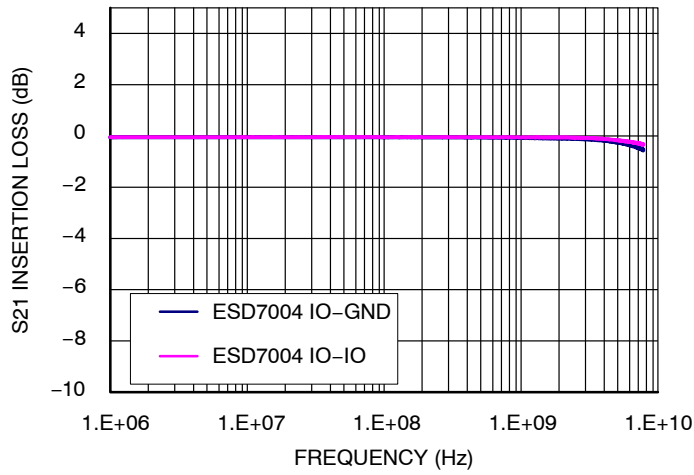

Figure 15. ESD7004 Insertion Loss

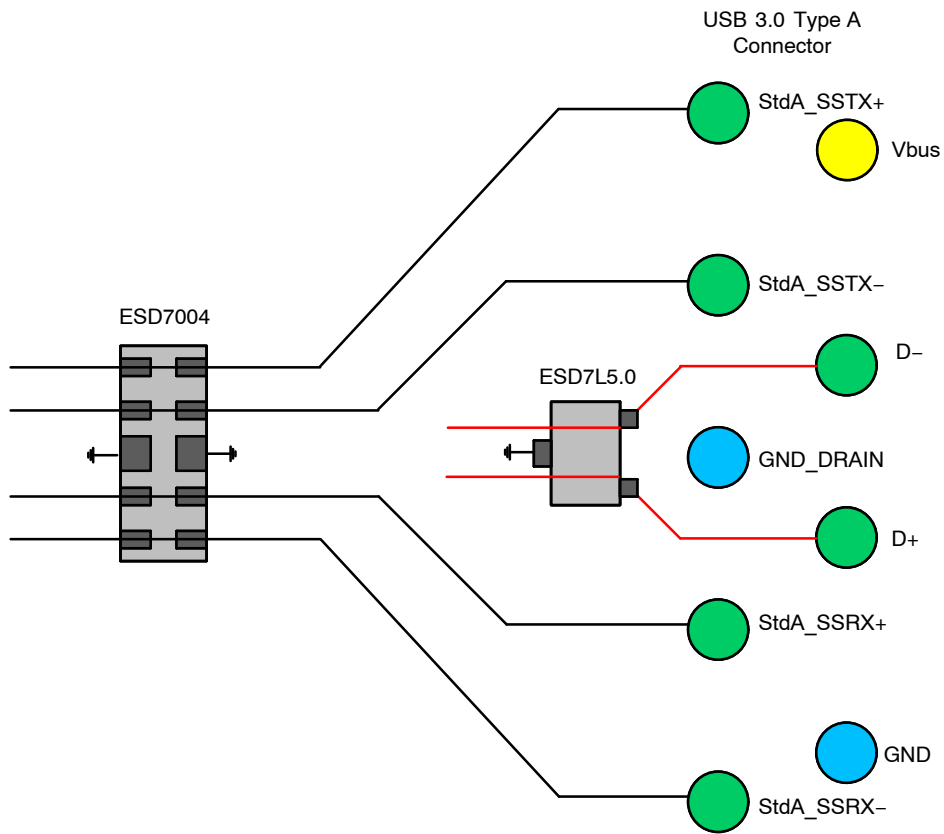

Figure 16. USB3.0 Layout Diagram

ESD7004

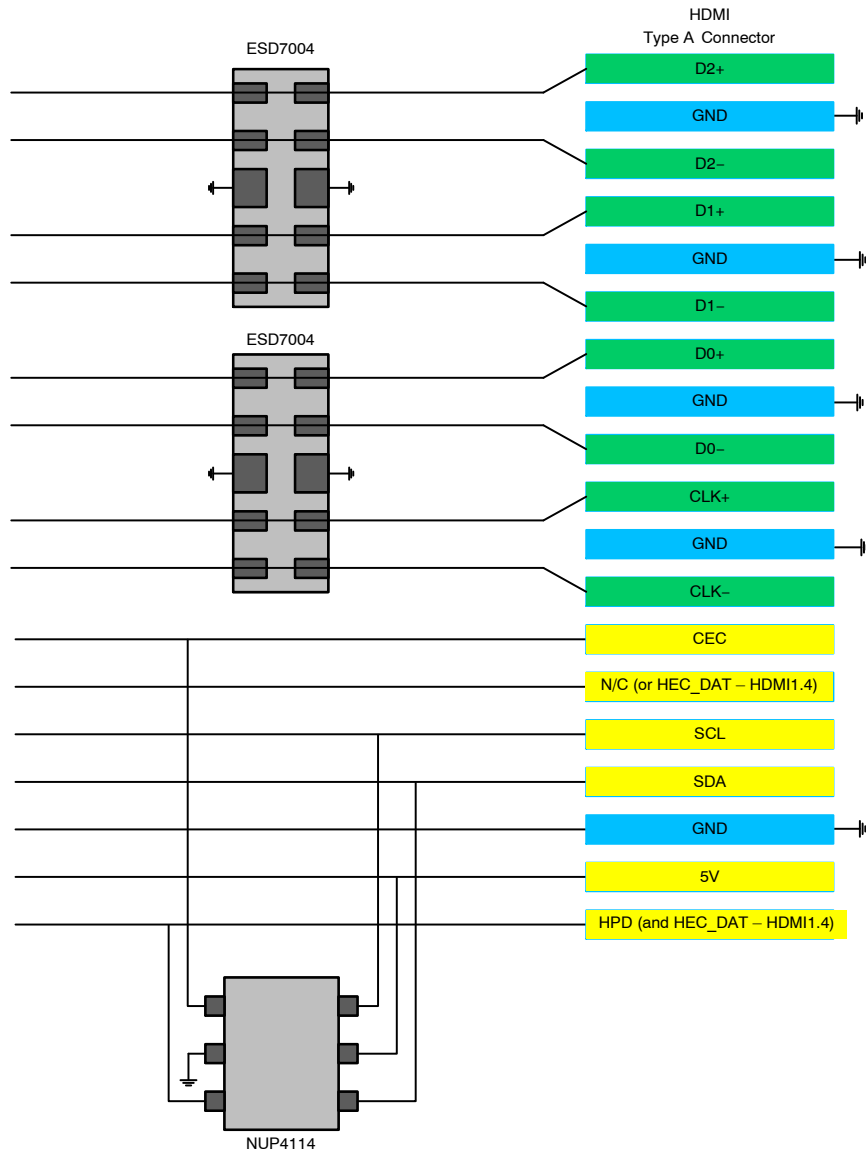

Figure 17. HDMI Layout Diagram

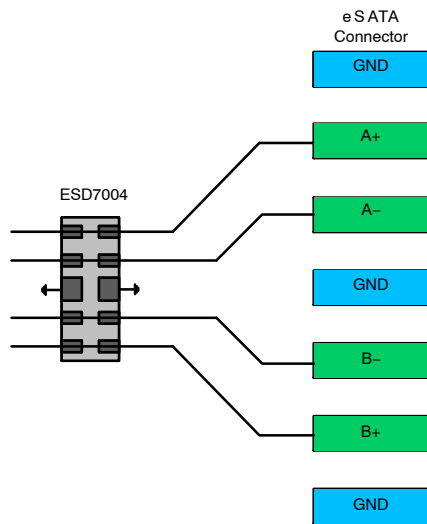
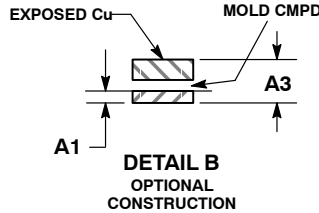
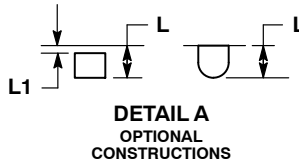
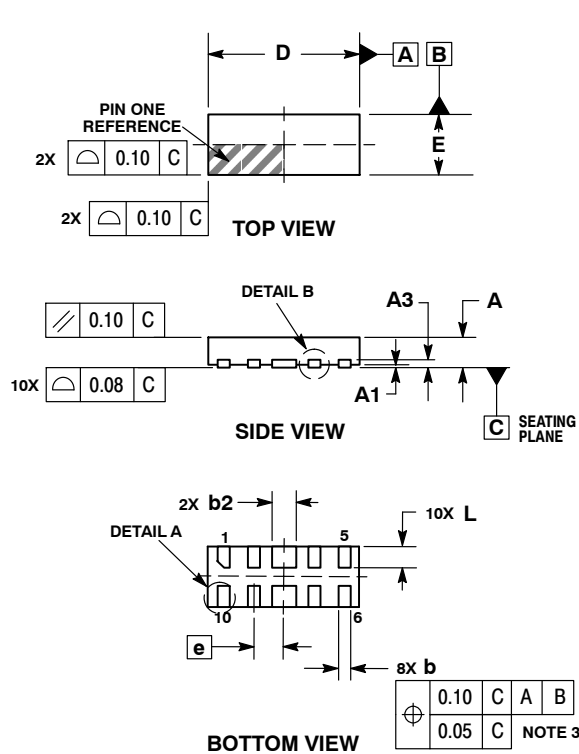

Figure 18. eSATA Layout Diagram

ESD7004

PACKAGE DIMENSIONS

UDFN10 2.5x1, 0.5P CASE 517BB-01 ISSUE O



- NOTES:
1. DIMENSIONING AND TOLERANCING PER ASME Y14.5M, 1994.
 2. CONTROLLING DIMENSION: MILLIMETERS.
 3. DIMENSION b APPLIES TO PLATED TERMINAL AND IS MEASURED BETWEEN 0.15 AND 0.30mm FROM TERMINAL.

DIM	MILLIMETERS	
	MIN	MAX
A	0.45	0.55
A1	0.00	0.05
A3	0.13 REF	
b	0.15	0.25
b2	0.35	0.45
D	2.50 BSC	
E	1.00 BSC	
e	0.50 BSC	
L	0.30	0.40
L1	---	0.05

RECOMMENDED SOLDERING FOOTPRINT*

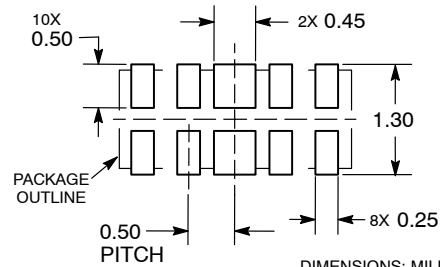

*For additional information on our Pb-Free strategy and soldering details, please download the ON Semiconductor Soldering and Mounting Techniques Reference Manual, SOLDERRM/D.

ON Semiconductor and are registered trademarks of Semiconductor Components Industries, LLC (SCILLC). SCILLC reserves the right to make changes without further notice to any products herein. SCILLC makes no warranty, representation or guarantee regarding the suitability of its products for any particular purpose, nor does SCILLC assume any liability arising out of the application or use of any product or circuit, and specifically disclaims any and all liability, including without limitation special, consequential or incidental damages. "Typical" parameters which may be provided in SCILLC data sheets and/or specifications can and do vary in different applications and actual performance may vary over time. All operating parameters, including "Typicals" must be validated for each customer application by customer's technical experts. SCILLC does not convey any license under its patent rights nor the rights of others. SCILLC products are not designed, intended, or authorized for use as components in systems intended for surgical implant into the body, or other applications intended to support or sustain life, or for any other application in which the failure of the SCILLC product could create a situation where personal injury or death may occur. Should Buyer purchase or use SCILLC products for any such unintended or unauthorized application, Buyer shall indemnify and hold SCILLC and its officers, employees, subsidiaries, affiliates, and distributors harmless against all claims, costs, damages, and expenses, and reasonable attorney fees arising out of, directly or indirectly, any claim of personal injury or death associated with such unintended or unauthorized use, even if such claim alleges that SCILLC was negligent regarding the design or manufacture of the part. SCILLC is an Equal Opportunity/Affirmative Action Employer. This literature is subject to all applicable copyright laws and is not for resale in any manner.

PUBLICATION ORDERING INFORMATION

LITERATURE FULFILLMENT:
Literature Distribution Center for ON Semiconductor
P.O. Box 5163, Denver, Colorado 80217 USA
Phone: 303-675-2175 or 800-344-3860 Toll Free USA/Canada
Fax: 303-675-2176 or 800-344-3867 Toll Free USA/Canada
Email: orderlit@onsemi.com

N. American Technical Support: 800-282-9855 Toll Free
USA/Canada
Europe, Middle East and Africa Technical Support:
Phone: 421 33 790 2910
Japan Customer Focus Center
Phone: 81-3-5773-3850

ON Semiconductor Website: www.onsemi.com
Order Literature: <http://www.onsemi.com/orderlit>
For additional information, please contact your local Sales Representative